

序号 (NO.)	品名 (Name)	材质 (Material)
①	0.5掀盖胶芯 (H=2.0) 0.5 Pitch Easy-on Type Housing (H=2.0)	LCP UL94V-0 本色 Natural
②	0.5掀盖端子 (H=2.0) 0.5 Pitch Easy-on Type Terminal (H=2.0)	铜合金/表面镀锡 Copper Alloy/ Tin Plating
③	0.5掀盖后盖 (H=2.0) 0.5 Pitch Easy-on Type Actuator (H=2.0)	LCP UL94V-0 黑色 Black
④	0.5掀盖焊片 (H=2.0) 0.5 Pitch Easy-on Type Fitting Nail (H=2.0)	铜合金/表面镀锡 Copper Alloy/ Tin Plating

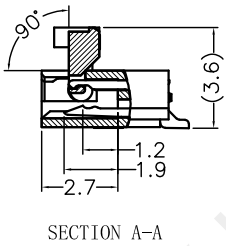
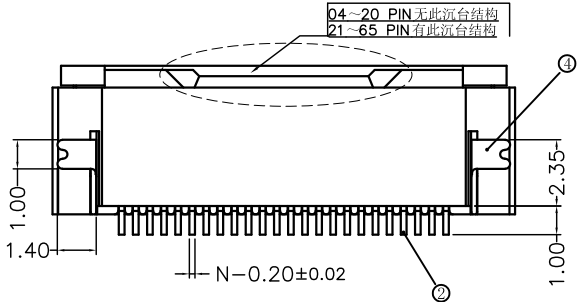
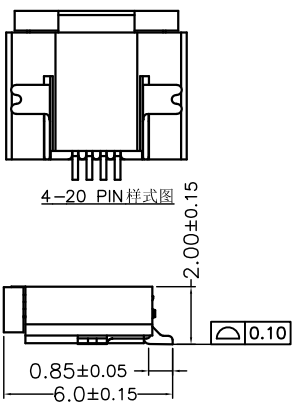
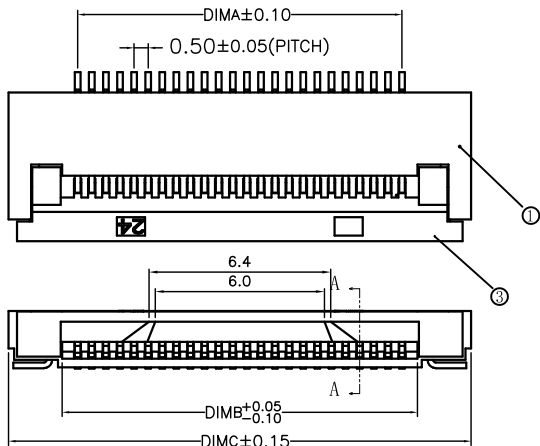
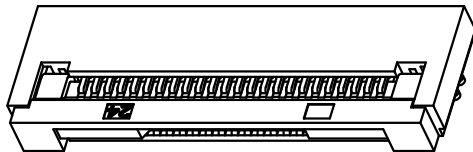

技术指标 (Technical Index):

1. 塑件表面应光洁、无毛边、无明显收缩、缺陷、裂纹等现象。(The surface of the plastic parts should be smooth, no rough edges, no obvious shrinkage, defects, cracks and other phenomena.)
2. 温度范围 (Temperature range): -25° C~85° C.
3. 额定电压 (Rated voltage): 50V, AC/DC (=等效).
4. 接触电阻 (Contact resistance): ≤0.03Ω.
5. 绝缘电阻 (Insulation resistance): ≥500MΩ.

CKT	DIMA	DIMB	DIMC	CKT	DIMA	DIMB	DIMC
4	1.50	2.60	6.40	34	16.50	17.60	21.40
5	2.00	3.10	6.90	35	17.00	18.10	21.90
6	2.50	3.60	7.40	36	17.50	18.60	22.40
7	3.00	4.10	7.90	37	18.00	19.10	22.90
8	3.50	4.60	8.40	38	18.50	19.60	23.40
9	4.00	5.10	8.90	39	19.00	20.10	23.90
10	4.50	5.60	9.40	40	19.50	20.60	24.40
11	5.00	6.10	9.90	41	20.00	21.10	24.90
12	5.50	6.60	10.40	42	20.50	21.60	25.40
13	6.00	7.10	10.90	43	21.00	22.10	25.90
14	6.50	7.60	11.40	44	21.50	22.60	26.40
15	7.00	8.10	11.90	45	22.00	23.10	26.90
16	7.50	8.60	12.40	46	22.50	23.60	27.40
17	8.00	9.10	12.90	47	23.00	24.10	27.90
18	8.50	9.60	13.40	48	23.50	24.60	28.40
19	9.00	10.10	13.90	49	24.00	25.10	28.90
20	9.50	10.60	14.40	50	24.50	25.60	29.40
21	10.00	11.10	14.90	51	25.00	26.10	29.90
22	10.50	11.60	15.40	52	25.50	26.60	30.40
23	11.00	12.10	15.90	53	26.00	27.10	30.90
24	11.50	12.60	16.40	54	26.50	27.60	31.40
25	12.00	13.10	16.90	55	27.00	28.10	31.90
26	12.50	13.60	17.40	56	27.50	28.60	32.40
27	13.00	14.10	17.90	57	28.00	29.10	32.90
28	13.50	14.60	18.40	58	28.50	29.60	33.40
29	14.00	15.10	18.90	59	29.00	30.10	33.90
30	14.50	15.60	19.40	60	29.50	30.60	34.40
31	15.00	16.10	19.90	61	30.00	31.10	34.90
32	15.50	16.60	20.40	64	31.50	32.60	36.40
33	16.00	17.10	20.90	65	32.00	33.10	36.90

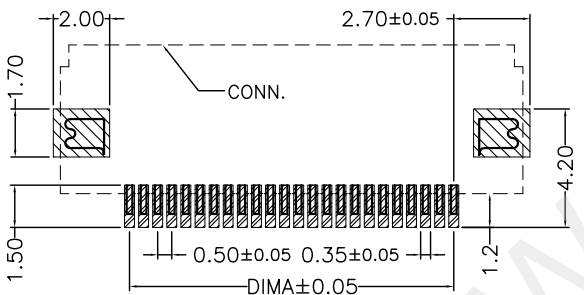

适用线路板 (PCB LAYOUT)

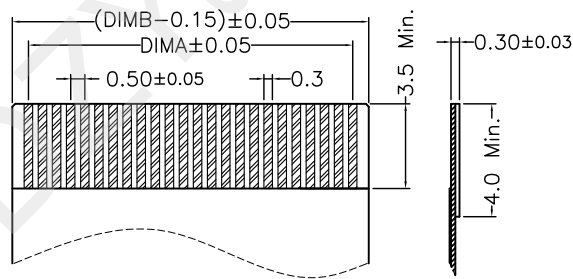

适用扁平线 (Applicable Flat Cable)

深圳市华宇创精密电子有限公司

TOLERANCE: X.X ±0.30 X.XX ±0.25 X.XXX ±0.15 X.' ±2' X.X' ±0.5'	DRAWN BY : 陈一鸣	DATE : 2014-02-23	PART NAME: 0.5PH 2.0H 掀盖下接FPC
	CHECKED BY: 马跃	DATE : 2014-02-23	PART NO. : HVC4C-05FPCXX-200
UNIT: mm [inch] SCALE:1:1 SIZE: A4	APPROVED BY: 邱敏	DATE : 2014-02-23	DRAW NO. : HVC-2412311131
			SHEET NO. : 1 OF 1